

DOI: <https://doi.org/10.15276/hait.05.2022.23>
UDC 004.662.99·519.6

Control of a thermoelectric cooling unit complex mixed electrical connection in an uneven temperature field

Vladimir P. Zaykov¹⁾

ORCID: <http://orcid.org/0000-0002-4078-3519>; gradan@i.u. Scopus Author ID: 57192640250

Vladimir I. Mescheryakov²⁾

ORCID: <http://orcid.org/0000-0003-0499-827X>; gradan@ua.fm. Scopus Author ID: 57192640885

Yurii I. Zhuravlov³⁾

ORCID: <http://orcid.org/0000-0001-7342-1031>; ivanovich1zh@gmail.com. Scopus Author ID: 57190425471

¹⁾ Research Institute “STORM”, 27, Tereshkova Str. Odessa, 65076, Ukraine

²⁾ State Environmental University, 15, Lvivska Str. Odessa, 65026, Ukraine

³⁾ National University “Odessa Maritime Academy”, 8, Didrikhson Str. Odessa, 65029, Ukraine

ABSTRACT

A possibility of optimal thermal management of a number of temperature-dependent and heat-laden elements of radio electronic equipment with different power dissipation in an uneven temperature field using a set of thermoelectric cooling devices with mixed electrical connection and fixed geometry of thermocouple branches has been considered. Ratios for determining the relative operating current corresponding to the minimum supply voltage at a given thermal load for different temperature gradients and thermocouple branch geometries are derived. The possibility of selecting a supply voltage for a group of thermoelectric coolers with parallel electric connection using both analytical and graphical methods of solving a system of algebraic equations of first and second orders is shown. The basic parameters, reliability indices and dynamic characteristics of a thermoelectric cooler complex with mixed electrical connection when a group of thermoelectric coolers with series electrical connection operates at maximum cooling capacity and supply voltage variation of a group of coolers with parallel electrical connection are evaluated. Analysis of the research results showed the possibility of selecting the optimum supply voltage for a group of thermoelectric coolers with parallel electric connection in the interrelation of energy, mass-dimensional and dynamic characteristics, taking into account the reliability indicators of the complex as a whole. It is shown that by reducing the supply voltage of a group of thermoelectric coolers with parallel electric connection included in the complex, the energy, mass-size and dynamic characteristics are improved, and the reliability of the complex with mixed electric connection in an uneven temperature field is increased.

Keywords: Thermoelectric cooler; thermal mode; connection models; supply voltage; reliability performance; dynamic performance

Copyright© Odessa Polytechnic National University, 2022. All rights reserved

For citation: Zaykov V. P., Mescheryakov V. I., Zhuravlov Yu. I. “Control of a thermoelectric cooling unit complex mixed electrical connection in an uneven temperature field”. *Herald of Advanced Information Technology*. 2022; Vol. 5 No. 4: 309–324. DOI: <https://doi.org/10.15276/hait.05.2022.23>

INTRODUCTION

One of the most acceptable ways of providing thermal modes and components of radio electronic equipment is thermoelectric, as the most effective in a wide range of operating temperatures from 140K to 350K. Thermoelectric cooling devices (TEC) allow controlling heat flow by simply changing the operating current value. The main advantages of thermoelectric cooling are the high reliability and small overall dimensions of the TEC, the ease of control and the speed of operation. These advantages inherently result from the solid-state nature of these coolers.

The design features of radio-electronic equipment include a dispersed arrangement of heat-loaded elements with different power dissipation. Therefore, in order to provide a given thermal mode of a number of heat-loaded and heat-dependent elements of radio electronic equipment, a group system of TEC layout with mixed electrical connection, located on one heat sink can be used. In this case, for a group of TEC connected electrically in parallel, different supply voltages can be used, finding the optimal ones taking into account a number of limiting factors for mass-size, power, dynamic and reliability characteristics.

For a group of TECs connected electrically in series, we select the current operating mode Q_{0max} ,

© Zaykov V., Mescheryakov V., Zhuravlov Yu., 2022

This is an open access article under the CC BY license (<http://creativecommons.org/licenses/by/3.0>)

and consequently, the value of the operating current for the mixed electrical connection: at different cooling level T_0 , the value of thermal load Q_0 , at the geometry of the thermocouple branches $l/S=4.5$, which is the subject of this paper.

LITERARY REVIEW

The generation of heat is an integral part of the operation of electronic equipment, facilitated by transients when components are in active mode. This leads to the need to dissipate excess heat - thermal management systems, as the reliability of operation is directly dependent on the temperature [1]. Thermoelectric thermal management systems are superior to all other types of coolers in terms of their mass-size, climatic and mechanical characteristics [2, 3]. However, the requirements for modern thermally loaded elements are increasing rapidly [4, 5], which leads to the need to improve the dynamic performance and reliability of thermal mode systems. According to thermal model the heat loaded element and its thermal mode support system are included in series, which leads to necessity of increasing its dynamic characteristics and reliability indexes [6, 7]. The study of influence of thermal load of fuel injection equipment on reliability indicators is devoted to work [8], however, the influence of design parameters was not considered in it. In [9] the results of analysis on reliability indices, and in [10] the current modes of operation are presented, which allowed to propose optimal conditions of TDP operation. The inclusion of TEC in the control loop extends the intellectual capabilities of thermal mode support systems, but the dynamic characteristics important for control have not even been considered [11]. The importance of this problem in relation to reliability in thermal devices is that as switching frequency increases, reliability performance decreases [12]. The difference in the linear temperature expansions of the substrate material and thermocouple branches leads to junction cracking [13]. The importance of the task of including TEC in the control circuit has led to a series of works related to the study of the relationship of dynamic characteristics and reliability indicators with the design [14], the number of thermocouples [15], current operating modes [16]. In works [17, 18] possibilities of optimization of reliability and dynamics indices of fuel injection equipment by complex criteria including these indices are substantiated. At the same time, the conducted researches concern the use of single TEC for thermal mode support systems. The task of controlling the thermal mode support

system of several TECs for distributed heat-loaded elements in an uneven temperature field remains relevant.

PURPOSE AND OBJECTIVES OF THE RESEARCH

The aim of the work is to improve the quality of thermal management of a set of thermoelectric cooling devices with mixed electrical connection in an uneven temperature field.

To achieve this goal it is necessary to solve the following tasks:

1. To develop a mathematical model of thermoelectric system of thermal modes provision with regard for reliability indicators and functioning dynamics.
2. To analyze developed model to identify optimal characteristics of thermoelectric cooler model.

DEVELOPMENT OF A MODEL OF THE THERMOELECTRIC DEVICE COMPLEX

To solve the first problem, we will use the known relations [19].

The number of thermoelectric elements n in TEC for a given heat load Q_0 and temperature drop ΔT can be determined from the relation:

$$n = \frac{Q_0}{I_{\max}^2 R(2B - B^2 - \Theta)}. \quad (1)$$

where Q_0 is the heat load value, W, or dissipation

power of the cooling object; $I_{\max} = \frac{\bar{e}T_0}{R}$ is

maximum operating current, A; \bar{e} is the averaged value of coefficient of thermoelectric EMF of the thermocouple branch at the end of the cooling process, V/K; T_0 – is temperature of heat-absorbing

junction, K; $R = \frac{l}{\bar{\sigma}S}$ is electrical resistance of the

thermocouple branch at the end of the cooling process, Ohm; l and S are, respectively, height and

cross-sectional area of the thermocouple branch; $\bar{\sigma}$ – is average conductivity value of the thermocouple branch, Sm/cm; $B_K = I/I_{\max}K$ is relative operating current at the end of the cooling process;

I is value of operating current, A; $\Theta = \frac{T - T_0}{\Delta T_{\max}}$ is

the relative temperature difference; is temperature of the fuel junction, K; $\Delta T_{\max} = 0,5 \bar{z} T_0^2$ is maximum temperature difference, K; \bar{z} is average value of thermoelectric raw materials in the module, 1/K.

The power consumption W of the TEU can be represented as:

$$W = 2nI_{\max}^2 RB \left(B + \frac{\Delta T_{\max}}{T_0} \Theta \right). \quad (2)$$

Voltage drop U_K :

$$U_K = \frac{W_K}{I}. \quad (3)$$

The cooling factor E can be calculated from the expression:

$$E = \frac{Q_0}{W_K}. \quad (4)$$

The relative failure rate of a single stage TEC λ/λ_0 can be determined from the expression [19]:

$$\frac{\lambda}{\lambda_0} = nB_K^2 (\Theta + c) \frac{\left(B_K + \frac{\Delta T_{\max}}{T_0} \Theta \right)^2}{\left(1 + \frac{\Delta T_{\max}}{T_0} \Theta \right)^2} K_T, \quad (5)$$

where $c = \frac{Q_0}{nI_{\max}^2 R}$ is the relative heat load; K_T is reduced temperature coefficient [19]; $\lambda_0 = 3 \cdot 10^{-8}$ is nominal failure rate, 1/hour.

The probability of no-failure operation P of the TEC can be determined from the expression:

$$P = \exp(-\lambda t), \quad (6)$$

where t is the designed lifetime, h.

The expression for the time of reaching the steady-state operation τ mode can be represented as [20]:

$$\tau = \frac{m_0 c_0 + \sum_i m_i c_i}{K \left(1 + 2B_K \frac{\Delta T_{\max}}{T_0} \right)} \ln \frac{\gamma B_H (2 - B_H)}{2B_K - B_K^2 - \Theta}, \quad (7)$$

where $m_0 c_0$ is the product of mass and heat capacity of the cooling object $\rightarrow 0$:

$\sum_i m_i c_i$ is the total value of products of heat capacity and mass of structural and technological elements at heat-absorbing junction of the module at given geometry of thermocouple branches (relations l/S);

$$\gamma = \frac{I_{\max H}^2 R_H}{I_{\max K}^2 R_K};$$

R_H is the electrical resistance of the thermocouple branch at the beginning of the cooling process, Ohm;

$B_H = \frac{I}{I_{\max H}}$ is relative operating current at the beginning of the cooling process at $\tau = 0$;

$I_{\max H} = \frac{e_H T}{R_H}$ is the maximum operating current at the start of the cooling process, A.

Assuming equal currents at the start and end of the cooling process:

$$I = B_K I_{\max K} = B_H I_{\max H}. \quad (8)$$

Block diagram of the complex with mixed electrical connection of TEC is shown in Fig. 1.

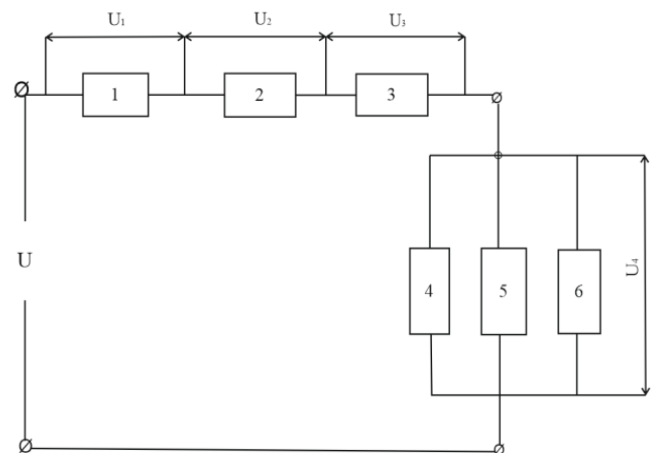

1 - $Q_0=5,0$ W 2 - $Q_0=10$ W 3 - $Q_0=15$ W
 4 - $Q_0=3,0$ W 5 - $Q_0=1,0$ W 6 - $Q_0=0,5$ W

Fig. 1. Connection diagram of thermoelectric coolers:

1 - $Q_0=5$ W; 2 - $Q_0=10$ W; 3 - $Q_0=15$ W;

4 - $Q_0=3$ W; 5 - $Q_0=1$ W; 6 - $Q_0=0,5$ W

Source: compiled by the authors

In the following, we will consider the mixed electrical connection of the TECs in a complex consisting of six TECs, three of which are connected electrically in series with a thermal load $Q_0=15W$, 10W, 5W, with a corresponding cooling temperature level $T_0=295K$, $T_0=290K$, $T_0=280K$. The remaining three are connected in parallel in a common circuit with a typical load $Q_0=3.0W$, 1.0W, 0.5W at the corresponding temperature cooling level $T_0=270K$, $T_0=160K$, $T_0=250K$ at fixed thermocouple geometry (ratio $l/S=4.5$).

The results of calculations of the basic parameters, reliability indicators and dynamic characteristics of a group of TEC with series electrical connection, one of which operates in the mode of Q_{0max} , are given in Table 1.

Consider a group of TEC units consisting of three chillers that are part of a complex, connected electrically in parallel and operating in an uneven temperature field and with different thermal load Q_0 . For this purpose, we will determine the minimum voltage value.

Using relations (1) and (3), it is possible to write down the expression for the supply voltage U of the TEC depending on the relative operating current B for a given temperature drop ΔT and the thermal load value Q_0 :

$$U = \frac{2Q_0 \left(B + \frac{\Delta T_{max}}{T_0} \Theta \right)}{I_{max} (2B - B^2 - \Theta)}, \quad (9)$$

either as a criterion

$$K = \frac{UI_{max}}{2Q_0} = \frac{\left(B + \frac{\Delta T_{max}}{T_0} \Theta \right)}{(2B - B^2 - \Theta)}, \quad (10)$$

which makes it possible to determine the optimum relative operating current B_{opt} corresponding to the minimum of the criterion K , or the supply voltage U_{min} at a given thermal load Q_0 for different temperature drops ΔT and the geometry of the thermocouple branches (ratio l/S).

Fig. 2 shows the dependence of TEC group value $K = \frac{UI_{max}}{2Q_0}$ on the relative operating current B for different relative temperature drops Θ .

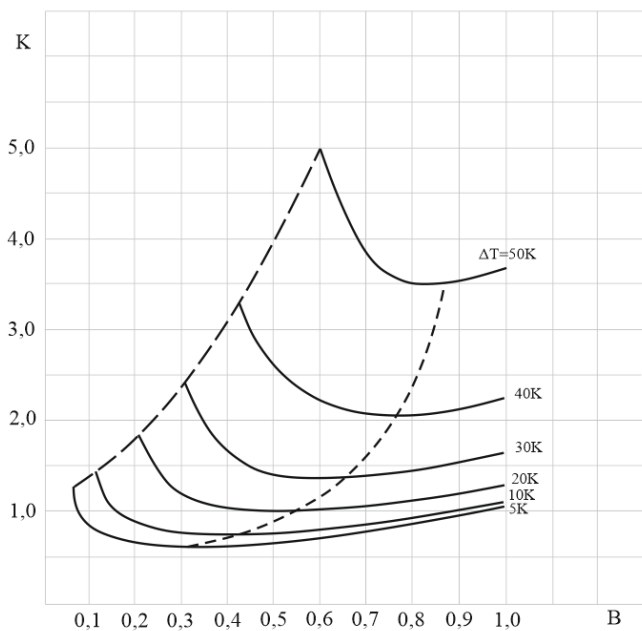

Fig. 2. Dependence $K = \frac{UI_{max}}{2Q_0}$ of TEC value and relative operating current B for different temperature differences ΔT at $T = 300K$, $l/S = 4,5$. The dotted line represents the geometric location of the points corresponding to the minimum of K_{opt}

Source: compiled by the authors

Table 1. Calculation results for the main parameters when connecting the TEC in series ($T = 300K$, $l/S = 4,5$, $I_0 = 11.7A$, $T - T_c = 5K$)

T_0 , K	Q_0 , W	B	Θ	n , pcs	W , W	U , V	E	τ	N , $W \cdot s$	αF , W/K	λ/λ_0	$\lambda \cdot 10^8$, $1/h$	P
280	5.0	1.0	0.213	9.7	13.6	1.16	0.37	2.7	36.3	3.7	9.8	29.4	0.9971
290	10.0	0.975	0.10	15.8	21.9	1.87	0.457	1.2	26.0	6.4	14.4	43.2	0.9957
295	15.0	0.967	0.848	21.9	30/2	2.58	0.50	0.6	19.0	9.0	19.2	57.5	0.9943
-	30.0	-	-	47.4	65.7	5.6	0.46	2.7	81,3	19.1	43.4	130.2	0.9870

Source: compiled by the authors

The functional dependence $K = f(B)$ has a minimum for different temperature drops. As the relative temperature drop Θ increases, the supply voltage U increases.

The optimum relative operating current B_{opt} corresponding to the minimum supply voltage U_{min} for a given thermal load Q_0 and branch geometry of the thermocouple l/S can be determined from the

$$B_{opt} = \frac{\left(1 - 2 \frac{\Delta T_{max}}{T_0} \Theta\right)}{\left(2 - \frac{\Delta T_{max}}{T_0} \Theta\right)} \left[1 + \sqrt{1 + \frac{\frac{\Delta T_{max}}{T_0} \Theta (2 + \Theta) \left(2 - \frac{\Delta T_{max}}{T_0} \Theta\right)}{\left(1 - 2 \frac{\Delta T_{max}}{T_0} \Theta\right)^2}} \right] \quad (11)$$

Fig. 3 shows the relationship between the optimum relative operating current B_{opt} and the relative temperature difference Θ corresponding to the current operating mode U_{min} .

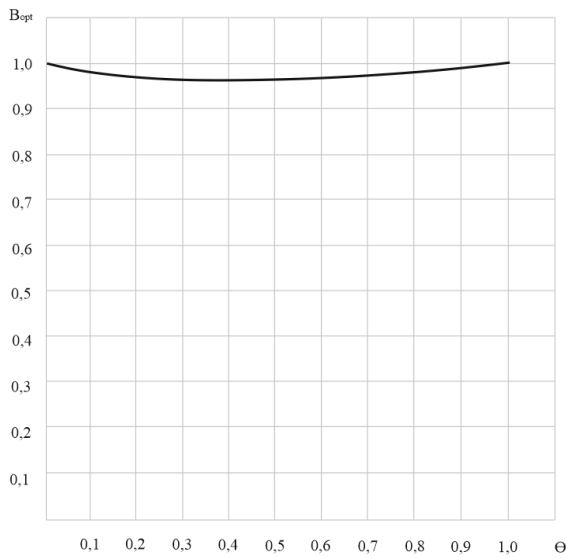

Fig. 3. Dependence of optimum operating current B_{opt} of a single stage TEC on the relative temperature difference Θ for current operation

$$\left(\frac{U}{Q_0}\right)_{min} \text{ at } T = 300K, l/S = 4,5$$

Source: compiled by the authors

It should be noted that the functional dependence $B_{opt} = f(\Theta) = 0.5$ has a minimum at, $B_{opt} = 0.96$.

condition $\frac{dK}{dB} = 0$. The formula for the optimum operating current B_{opt} corresponding to the minimum supply voltage U_{min} at a given thermal load Q_0 can be written as follows:

Fig. 4 shows the dependence of the minimum supply voltage U_{min} on the thermal load value Q_0 for different temperature drops ΔT .

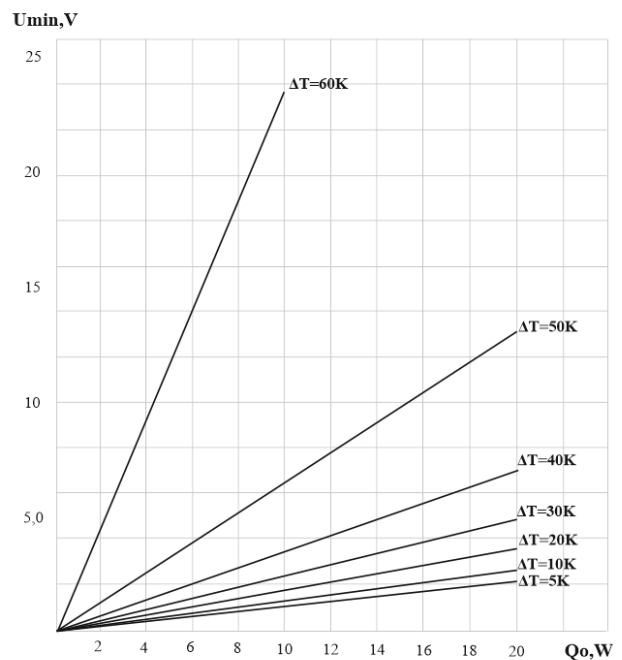

Fig. 4. Dependence of the minimum supply voltage U_{min} of a group of parallel-connected TECs on the heat load Q_0 for different temperature differentials ΔT at $T = 300K, l/S = 4,5$

Source: compiled by the authors

As the temperature drop ΔT increases, the minimum supply voltage U_{min} increases for a given thermal load U_{min} . By evaluating the value U_{min} , it is possible to select the supply voltage

$U \geq U_{\min}$ for the group of TECs in parallel electrical connection.

Using expressions (9) or (10) it is possible to determine the relative operating current B for a group of TEC in parallel at a given supply voltage U and a given thermal load Q_0 , and the relative temperature drop Θ at a fixed geometry of the thermocouple branches l/S :

$$KB^2 - B(2K - 1) + \Theta \left(K + \frac{\Delta T_{\max}}{T} \right) = 0, \quad (12)$$

where $K = \frac{UI_{\max}}{2Q_0}$.

Analysis of relation (12) shows that in the absence of a heat load $Q_0 \rightarrow 0$, $B \rightarrow \infty$, expression (12) can be written as:

$$B = 1 - \sqrt{1 - \Theta}. \quad (13)$$

At $\Theta \rightarrow 0$ $B \rightarrow 0$.

Thus, with a given value $K = \frac{UI_{\max}}{2Q_0}$ it is

possible to determine the relative operating current B for various temperature differences ΔT .

Fig. 5 shows the dependence of the value K on the relative operating current B for different temperature differences ΔT . The dotted line indicates the geometric location of the points corresponding to the minimum of K_{\min} .

As the temperature drop ΔT increases, the value K at a given relative operating current B increases.

We use a system of equations to determine the basic parameters, reliability and dynamic characteristics of the part of the complex TEC with parallel electrical connection:

$$\begin{cases} I_{\Sigma} = I_1 + I_2 + I_3 \\ K_1 B_1^2 - B_1(2K_1 - 1) + \Theta_1 \left(K_1 + \frac{\Delta T_{\max}}{T_0} \right) = 0 \\ K_2 B_2^2 - B_2(2K_2 - 1) + \Theta_2 \left(K_2 + \frac{\Delta T_{\max}}{T_0} \right) = 0 \\ K_3 B_3^2 - B_3(2K_3 - 1) + \Theta_3 \left(K_3 + \frac{\Delta T_{\max}}{T_0} \right) = 0 \end{cases} \quad (14)$$

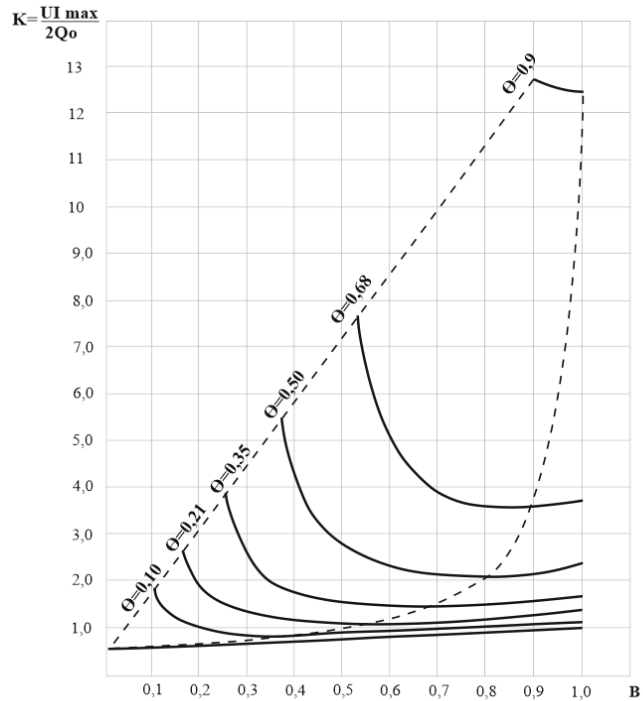

Fig. 5. Dependence $K = \frac{UI_{\max}}{2Q_0}$ of single stage

TEC magnitude on relative operating current B for different relative temperature drops Θ at

$T = 300K, l/S = 4,5$

Source: compiled by the authors

where I_{Σ} is the magnitude of the operating current of the part of the TEC complex with series electrical connection, A ; I_1, I_2, I_3 is respectively, the operating currents in the three parallel circuits, A ; Q_{01}, Q_{02}, Q_{03} is the value of thermal load of the corresponding parallel chain; l/S is geometry of thermoelement branches is the same in all chains $l/S = 4.5$; U is the supply voltage of the part of the TEC complex with parallel electric connection; $\Theta_1, \Theta_2, \Theta_3$ are respectively, relative temperature differences in the different circuits of the part of the TEC complex with parallel electric connection.

ANALYSIS OF THE COMPLEX MODEL IN AN UNEVEN TEMPERATURE FIELD

Results of calculations of basic parameters, reliability indices and dynamic characteristics of a part of the complex TEC with parallel electric connection in the uneven temperature field with different thermal load T_0 at the fixed geometry of

thermoelement branches $l/S=4.5$ for different supply voltages U , are given in Table 2.

A graphical method can be used to determine the relative operating current B in each parallel circuit.

Fig. 6 shows the dependence of the supply voltage U of a group of TECs in parallel with the relative operating current B for different thermal loads Q_0 and cooling levels T_0 in a non-uniform temperature field.

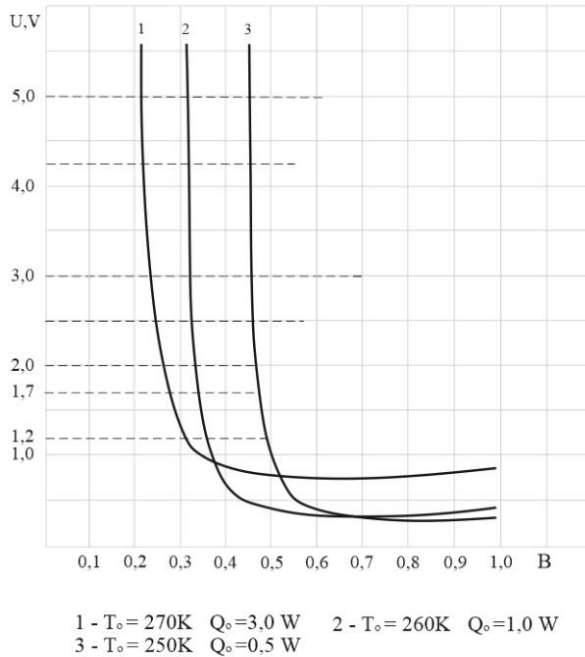

Fig. 6. Dependence of the supply voltage U of a group of parallel-coupled TECs on the relative operating current B for different levels T_0 of cooling and thermal load Q_0 at

$T = 300\text{K}$, $l/S = 4.5$:
 1 - $T_0 = 270\text{K}$; $Q_0 = 3.0\text{W}$; 2 - $T_0 = 260\text{K}$;
 $Q_0 = 1.0\text{W}$; 3 - $T_0 = 250\text{K}$; $Q_0 = 0.5\text{W}$

Source: compiled by the authors

The functional dependence $U = f(B)$ has a minimum:

- 1) $U_{\min} = 0.75\text{V}$ at $B_{\text{opt}} = 0.7$ for $Q_0 = 3.0\text{W}$, $T_0 = 270\text{K}$;
- 2) $U_{\min} = 0.3\text{V}$ at $B_{\text{opt}} = 0.87$ for $Q_0 = 1.0\text{W}$, $T_0 = 260\text{K}$;
- 3) $U_{\min} = 0.35\text{V}$ at $B_{\text{opt}} = 0.9$ for $Q_0 = 0.5\text{W}$, $T_0 = 250\text{K}$.

When selecting the supply voltage U for each TEC from the group with parallel electric connection, the condition must be observed $U \geq U_{\min}$.

As the supply voltage U increases for each TEC from the group with parallel electric connection for different thermal load Q_0 and cooling level T_0 in an uneven temperature field:

– the value of the operating current I decreases (Fig. 7);

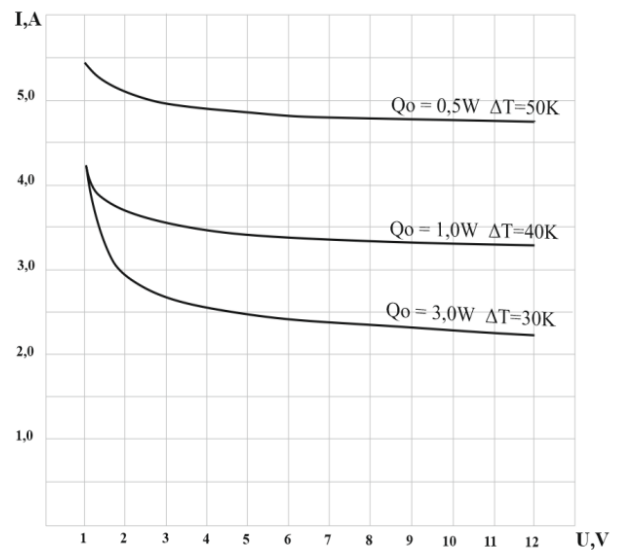

Fig. 7. Dependence of the operating current I of a TEC from a group with parallel electric connection on the supply voltage U for different thermal loads Q_0 on the cooling level T_0 at $T = 300\text{K}$, $l/S = 4.5$

Source: compiled by the authors

- the number of thermocouples n increases (Fig. 8);
- the cooling factor E is reduced (Fig. 9);
- the steady-state time τ increases (Fig. 10);
- the required heat dissipation capacity αF of the radiator is increased (Fig. 11);
- the amount of energy expended N increases (Fig. 12);
- the relative failure rate λ/λ_0 increases (Fig. 13);
- the probability of failure-free operation P decreases (Fig. 14).

For a group of TECs with parallel electric connection, we will determine the main parameters, reliability indicators and dynamic characteristics in an uneven temperature field with different thermal loads for different supply voltages. The data for the calculations are shown in Table 3.

Table 2. Uneven temperature field. Parallel connection of a group of TEU complexes

$$T = 300K, l/S = 4.5$$

Q_0	Θ	B	l	n	W	E	τ	N	αF	A	T_0	λ/λ_0	$\lambda \cdot 10^8$	P
-------	----------	-----	-----	-----	-----	-----	--------	-----	------------	-----	-------	---------------------	----------------------	-----

$U = 1.0V$

3.0	0.346	0.365	4.16	19.7	4.16	0.72	9.9	41	1.4	0.53	270	0.29	0.87	0.999913
1.0	0.50	0.361	4.05	19.2	4.05	0.25	20	82	1.0	0.18	260	0.30	0.91	0.999909
0.5	0.68	0.493	5.4	15.0	5.4	0.093	25.0	134	1.2	0.092	250	0.92	2.8	0.99972
4.5	-	-	13.6	53.9	13.6	0.33	25.0	257	3.6	-	-	1.51	4.53	0.99955

$U = 1.2V$

3.0	0.346	0.317	3.6	26.3	4.35	0.69	11.9	52.0	1.5	0.44	270	0.21	0.64	0.999936
1.0	0.50	0.35	3.9	23.7	4.7	0.21	22.0	103	1.1	0.15	260	0.32	0.96	0.999904
0.5	0.68	0.48	5.25	18.4	6.3	0.08	26.8	169	1.4	0.076	250	1.03	3.1	0.99969
4.5	-	-	12.75	68.4	15.4	0.29	26.8	324	4.0	-	-	1.56	4.7	0.99953

$U = 1.5V$

3.0	0.346	0.28	3.2	35.9	4.8	0.62	14.2	69	1.6	0.35	270	0.17	0.52	0.999948
1.0	0.50	0.335	3.8	30.4	5.7	0.18	24.4	138	1.3	0.12	260	0.35	1.05	0.999895
0.5	0.68	0.47	5.1	23.4	7.7	0.065	29.0	224	1.6	0.06	250	1.2	3.6	0.99964
4.5	-	-	12.1	89.7	18.2	0.25	29.0	431	4.5	-	-	1.72	5.2	0.99948

$U = 1.7V$

3.0	0.346	0.267	3.0	42.0	5.2	0.58	15.5	80	1.6	0.31	270	0.16	0.49	0.999951
1.0	0.50	0.33	3.7	34.7	6.3	0.16	25.6	160	1.45	0.105	260	0.38	1.12	0.999888
0.5	0.68	0.46	5.1	26.5	8.6	0.06	30.1	259	1.8	0.054	250	1.3	3.9	0.99961
4.5	-	-	11.8	103.2	20.1	0.22	30.1	499	4.9	-	-	1.84	5.52	0.99945

$U = 2.0V$

3.0	0.346	0.25	2.9	51.2	5.7	0.52	17.2	99.0	1.75	0.26	270	0.16	0.47	0.999953
1.0	0.50	0.32	3.6	41.2	7.2	0.14	27.2	196	1.6	0.09	260	0.41	1.24	0.999876
0.5	0.68	0.46	5.0	30.8	9.8	0.05	31.5	310	2.1	0.046	250	1.45	4.35	0.99957
4.5	-	-	11.5	123.2	22.7	0.20	31.5	605	5.45	-	-	2.0	6.0	0.99940

$U = 3.0V$

3.0	0.346	0.23	2.6	82.6	7.8	0.38	21.5	168	2.2	0.175	270	0.17	0.50	0.999950
1.0	0.50	0.31	3.5	63.3	10.5	0.095	31.3	328	2.3	0.06	260	1.05	3.2	0.99968
0.5	0.68	0.45	4.9	47.8	14.7	0.034	35.5	522	3.0	0.03	250	2.05	6.2	0.99938
4.5	-	-	11.0	193.7	33.0	0.14	35.5	1018	7.5	-	-	3.3	9.8	0.9990

$U = 6.0V$

3.0	0.346	0.21	2.4	173.8	14.2	0.21	28.7	406	3.4	0.09	270	0.24	0.71	0.999929
1.0	0.50	0.30	3.4	130	20.3	0.05	38.4	780	4.3	0.03	260	0.98	2.95	0.99970
0.5	0.68	0.44	4.8	97.4	29.0	0.017	42.2	1222	5.9	0.015	250	3.9	11.6	0.99884
4.5	-	-	10.6	401.2	63.5	0.070	42.2	2408	13.6	-	-	5.1	15.4	0.9985

$U = 9.0V$

3.0	0.346	0.20	2.3	262	20.3	0.15	32.9	669	4.7	0.06	270	0.32	0.96	0.99990
1.0	0.50	0.30	3.35	196.4	30.2	0.033	42.4	1278	6.2	0.02	260	1.4	4.2	0.99958
0.5	0.68	0.44	4.8	149.1	43.8	0.011	46.3	2028	8.9	0.01	250	5.7	17.2	0.9983
4.5	-	-	10.5	607.5	94.3	0.05	46.3	3975	19.8	-	-	7.4	22.3	0.9978

$U = 12.0V$

3.0	0.346	0.20	2.3	359.8	27.2	0.11	36.2	984	6.0	0.044	270	0.41	1.22	0.99988
1.0	0.50	0.30	3.3	246	37.5	0.027	44.6	1672	7.7	0.015	260	1.74	5.2	0.99948
0.5	0.68	0.44	4.78	180.7	52.9	0.01	48.0	2539	10.7	0.0076	250	6.9	20.7	0.9978
4.5	-	-	10.4	786.5	117.6	0.04	48.0	5195	24.4	-	-	9.0	27.0	0.9973

Source: compiled by the authors

Table 3. Results of calculations of main parameters and indices for group of TEC in non-uniform temperature field

$$T = 300K, l/S = 4.5, Q_0 = 4.5W$$

No.	U, V	n, pcs	W, W	E	τ, s	$N, W \cdot s$	$\alpha F, W/K$	I_0, A	λ/λ_0	$\lambda \cdot 10^8, 1/h$	P
1	1.0	53.9	13.6	0.33	25.0	257	3.6	13.6	1.51	4.53	0.99955
2	1.2	68.4	15.4	0.29	27.0	324	4.0	12.7	1.56	4.7	0.99953
3	1.5	89.7	18.2	0.25	29.0	431	4.5	12.1	1.72	5.2	0.99948
4	1.7	103.2	20.1	0.22	30.0	499	4.9	11.8	1.84	5.52	0.99945
5	2.0	123.2	22.7	0.20	32.0	605	5.45	11.5	2.0	6.0	0.99940
6	3.0	193.7	33.0	0.14	36.0	1018	7.5	11.0	3.3	98	0.9990
7	6.0	401	63.5	0.07	42.0	2404	13.6	10.6	5.1	15.4	0.9985
8	9.0	607	94.3	0.05	46.0	3975	19.8	10.5	7.4	22.3	0.9978
9	12.0	787	117.6	0.04	48.0	5195	24.4	10.4	9.0	27.0	0.9973

Source: compiled by the authors

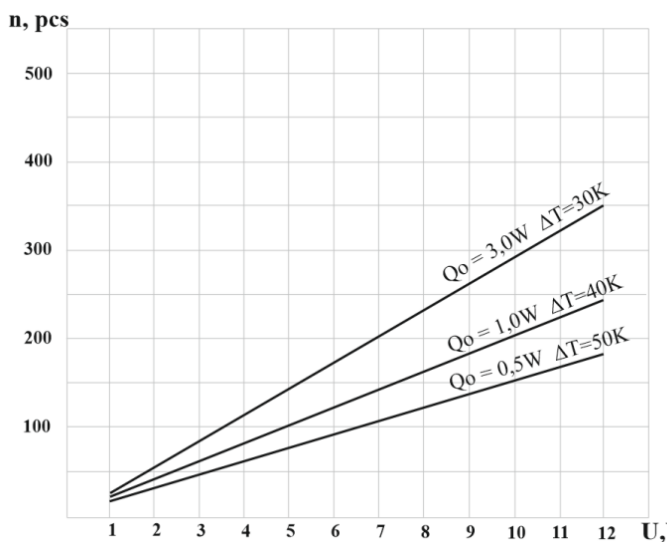

Fig. 8. Dependence of number of thermocouples n from the group with parallel electric connection on supply voltage U for different thermal load Q_0 and cooling level ΔT at

$$T = 300K, l/S = 4.5$$

Source: compiled by the authors

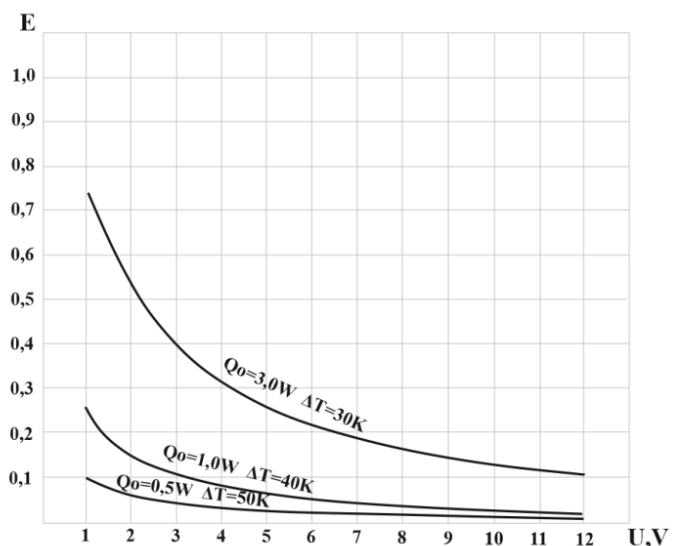

Fig. 9. Dependence of the cooling factor E of the TEC from the group with parallel electric connection on the supply voltage U for different heat load Q_0 and cooling levels T_0 at

$$T = 300K, l/S = 4.5$$

Source: compiled by the authors

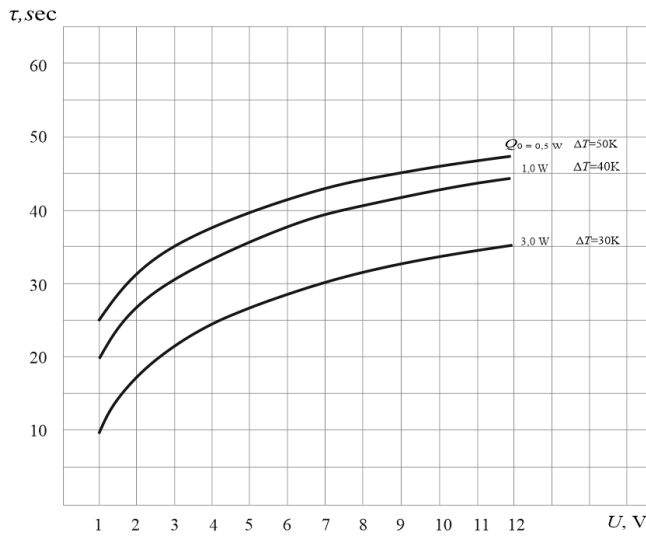

Fig. 10. Dependence of time τ to steady-state operation of the TEC from the group with parallel electric connection on supply voltage U for different thermal load Q_0 and cooling level at $T = 300\text{K}$, $l/S = 4.5$
 Source: compiled by the authors

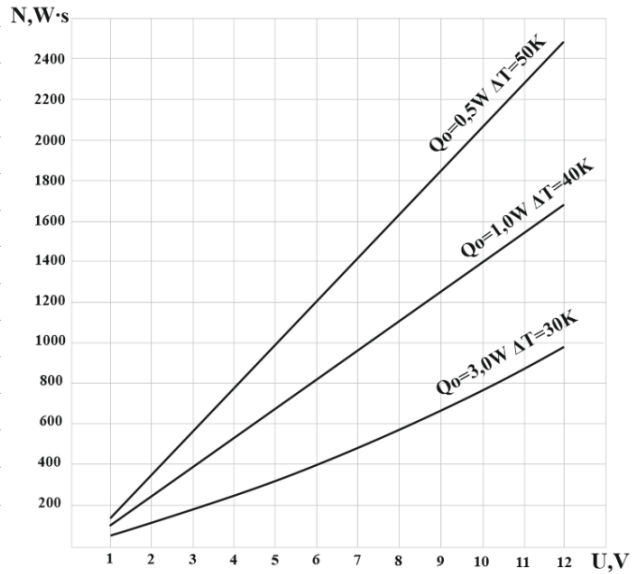

Fig. 12. Dependence of the amount of energy expended N by the TEC from the group with parallel electric connection on the supply voltage U for different thermal load Q_0 and cooling level T_0 at $T = 300\text{K}$, $l/S = 4.5$
 Source: compiled by the authors

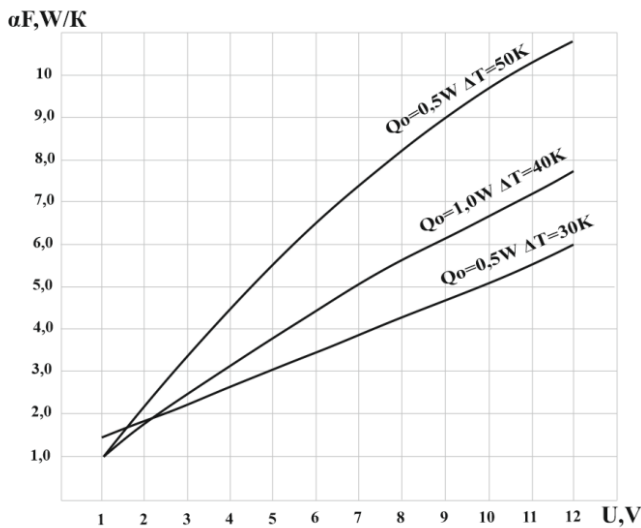

Fig. 11. Dependence of heat dissipation capacity αF of the heatsink from the group with parallel electric connection on supply voltage U for different heat load Q_0 mi cooling level T_0 at $T = 300\text{K}$, $l/S = 4.5$
 Source: compiled by the authors

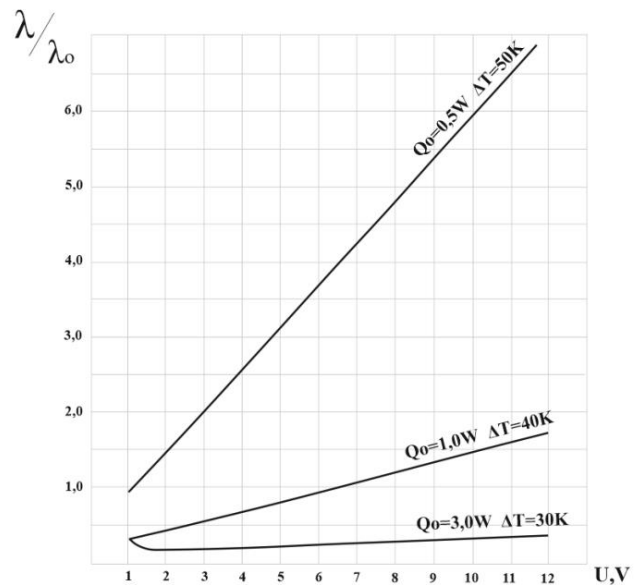

Fig. 13. Dependence of relative failure rate λ/λ_0 of TECs from the group with parallel electric connection on supply voltage U for different thermal load Q_0 and cooling level T_0 at $T = 300\text{K}$, $l/S = 4.5$
 Source: compiled by the authors

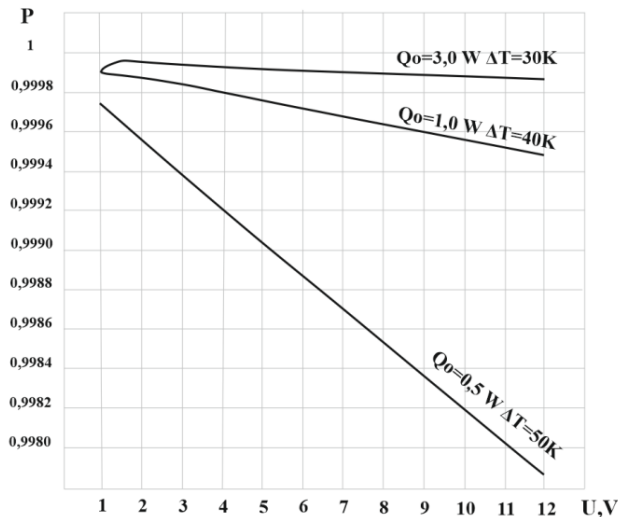

Fig. 14. Relation of the probability of no-failure operation P of the TEC from the group with parallel electric connection to the supply voltage U for different thermal load Q_0 and cooling level T_0 at $T = 300K$, $l/S = 4.5$

Source: compiled by the authors

As the supply voltage U increases for a group of TECs with parallel electric connection in an uneven temperature field with total heat load $Q_0 = 4.5W$ and thermocouple branch geometry $l/S = 4.5$:

- the cooling coefficient E decreases (Fig. 15, item 1);
- the number of thermoelements n increases

(Fig. 15, item 2);

– steady-state operation time τ increases (Fig. 15, item 3);

– the operating current I decreases (Fig. 16, item 1);

– the required heat dissipation capability αF of the heat sink increases (Fig. 16, item 2)

– the amount of energy expended N increases (Fig. 16, item 3);

– the relative failure rate λ/λ_0 increases (Fig. 17, item 1);

– the probability of no-failure operation P decreases (Fig.17, item 2).

The results of calculations of the main parameters, reliability indicators and dynamic characteristics of the complex with mixed electrical connection of TEC (three connected in series and three in parallel) in an uneven temperature field are given in Table 4.

As the supply voltage U of a group of TECs with parallel electric connection of a TEC complex with a total heat load $Q_0 = 34.5W$ and thermocouple branch geometry $l/S = 4.5$ in an irregular temperature field increases:

– the cooling coefficient E decreases (Fig. 18, item 1);

– the number of thermocouples n increases (Fig. 18, item 2)

– time to reach steady-state operation τ increases (Fig. 18, item 3);

Table 4. Mixed electrical connection of the TEC complex.

$T = 300K$; $l/S = 4.5$; $T - T_c = 5K$; $Q_0 = 34.5W$

No.	U, V	W, W	E	U_{Σ}, V	n, pcs	τ_{Σ}, s	$\alpha F_{\Sigma}, W/K$	$N_{\Sigma}, W \cdot s$	$\lambda/\lambda_{0\Sigma}$	$\lambda \cdot 10^8$ 1/h	P_{Σ}
1	1.0	79.3	0.435	6.6	101.3	25.0	22.7	338	44.9	134.7	0.98662
2	1.2	81.1	0.425	6.8	115.8	26.8	23.1	405	45.0	135	0.98659
3	1.5	83.9	0.411	7.1	137.1	29.0	23.6	512	45.12	135.4	0.98655
4	1.7	85.8	0.402	7.3	150.6	30.0	24.0	580	45.2	135.7	0.98652
5	2.0	88.4	0.39	7.6	170.6	31.5	24.6	686	45.4	136.2	0.98647
6	3.0	98.7	0.35	8.6	241.1	36.0	26.7	1100	46.7	140.5	0.9861
7	6.0	129.2	0.267	11.6	449	42.0	32.7	2490	48.5	145.5	0.98555
8	9.0	160.0	0.216	14.6	655	46.0	38.9	4056	50.8	152.4	0.9849
9	12.0	183.3	0.19	17.6	834	48.0	43.5	5276	52.4	157.2	0.9844

Source: compiled by the authors

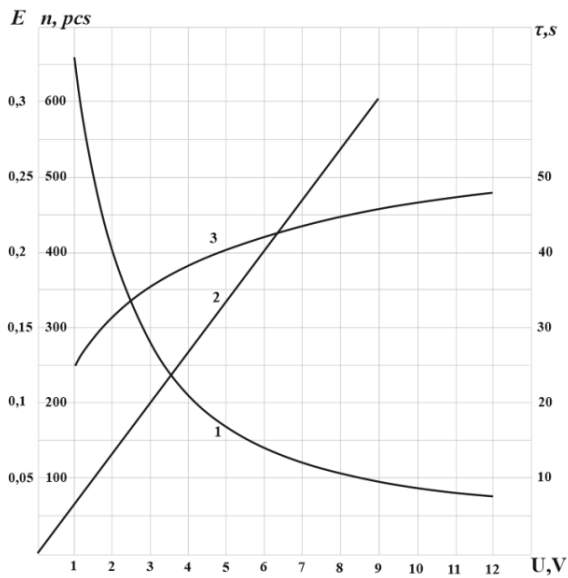

Fig. 15. Dependence of refrigerating factor E , ramp-up time τ , number of thermocouples n in the group of TECs with parallel electric connection on supply voltage U at $T = 300K, l/S = 4.5, Q_0 = 4.5W$
 $1 - E = f(U), 2 - n = f(U), 3 - \tau = f(U)$
 Source: compiled by the authors

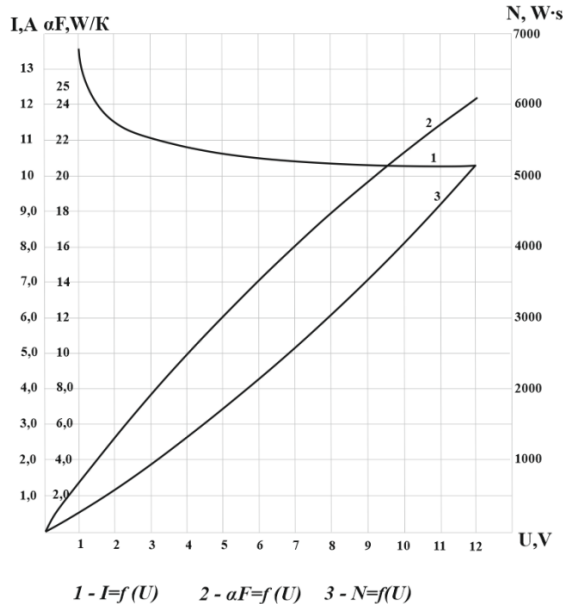

Fig. 16. Dependence of operating current I , heat dissipation capacity αF of the heatsink and amount of energy expended N by the TEC group with parallel electric connection as a function of supply voltage U at $T = 300K, l/S = 4.5, Q_0 = 4.5W$
 Source: compiled by the authors

- increases energy N consumption (Fig. 19, item 1);
- the required heat dissipation capacity of the heat sink αF increases (Fig. 19, item 2);
- the relative failure rate λ/λ_0 increases (Fig. 20, item 1);
- the probability of failure-free operation P decreases (Fig. 20, item 2).

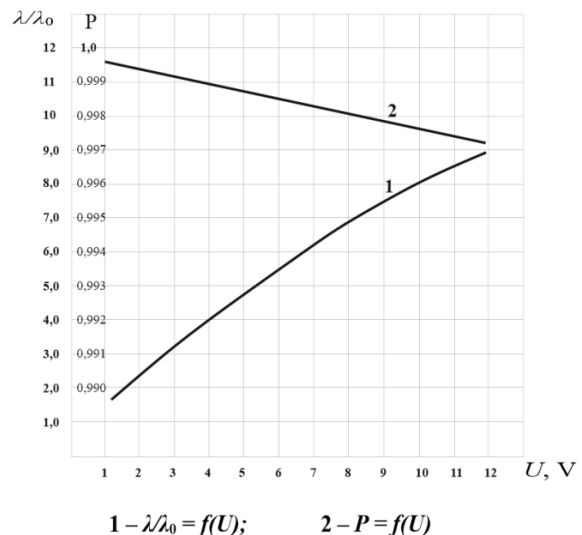

Fig. 17. Dependence of the relative failure rate λ/λ_0 and the probability P of no-failure operation for the parallel electric connection on the supply voltage U at $T = 300K, l/S = 4.5; = 4.5W; \lambda_0 = 3 \cdot 10^{-8} 1/h; t = 10^4 h$
 Source: compiled by the authors

CONCLUSIONS

A thermophysical model of thermal mode support system has been developed on the basis of the complex of thermoelectric elements with mixed electrical connection to control the thermal mode of a number of heat-dependent elements of radio-electronic equipment in an uneven temperature field with different load Q_0 at geometry of thermoelement branches $l/S = 4.5$.

The relations for determining the relative operating current B depending on supply voltage U , temperature differential ΔT , heat load Q_0 for a group of TECs with parallel electric connection in an uneven temperature field at fixed geometry of thermocouple branches $l/S = 4.5$ are obtained.

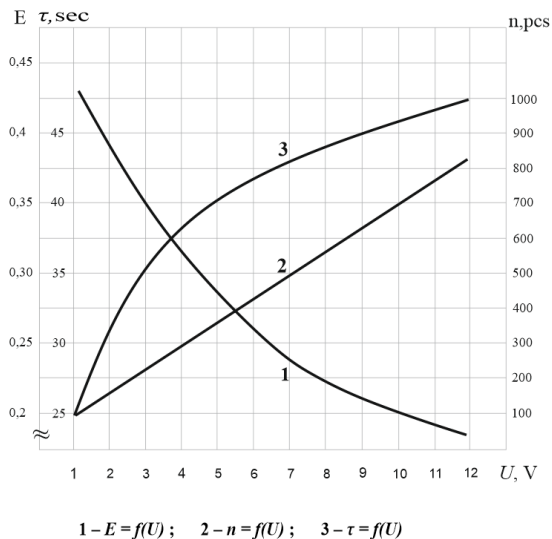

Fig. 18. Dependence of refrigerating factor E , number of thermocouples n , time to reach steady-state mode of the TEC complex with mixed electrical connection on the supply voltage U of the TEC group with parallel electrical connection in an uneven temperature field at $T = 300K, l/S = 4.5, Q_0 = 34.5W$.

1 - $E = f(U)$, 2 - $n = f(U)$, 3 - $\tau = f(U)$
 Source: compiled by the authors

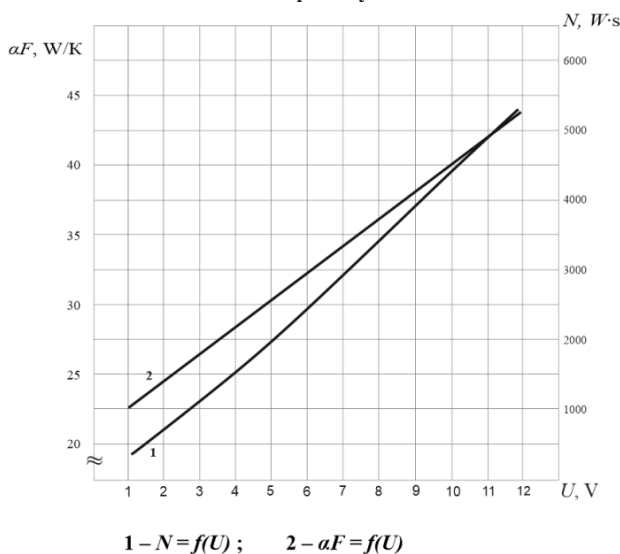

Fig. 19. Dependence of the amount of energy input N , required heat dissipation capacity of the heat sink αF of the mixed electrical connection TEC complex on the supply voltage U of the TEC group with parallel electrical connection in an uneven temperature field at $T = 300K, l/S = 4.5, Q_0 = 34.5W$.

1 - $N = f(U)$, 2 - $\alpha F = f(U)$
 Source: compiled by the authors

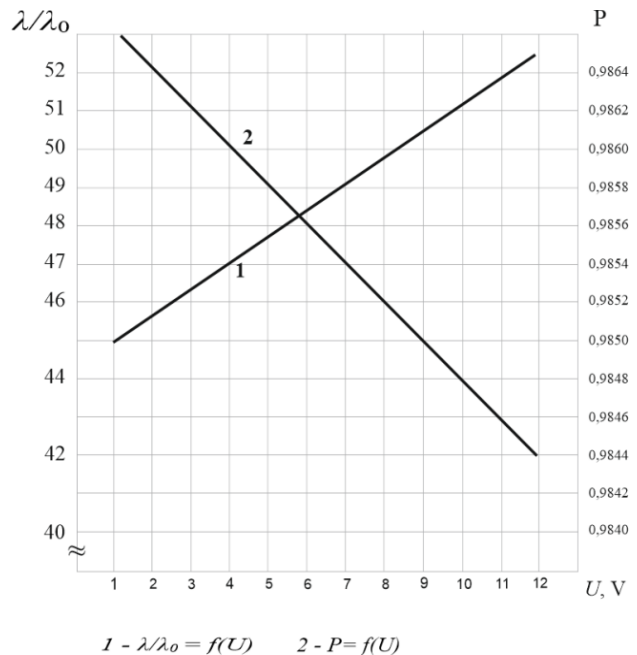

Fig. 20. Dependence of the relative failure rate λ/λ_0 and the probability P of no-failure operation of a mixed electrical coupled TEC complex on the supply voltage U of a group of TECs with parallel electrical coupling in a non-uniform temperature field at $T = 300K, l/S = 4.5, Q_0 = 4.5W$,

$\lambda_0 = 3 \cdot 10^{-8} 1/h, t = 10^4 h$
 Source: compiled by the authors

A comparative analysis of the main parameters, reliability indices and dynamic characteristics of a complex of fuel injection equipment with mixed electrical connection in an uneven temperature field depending on the supply voltage of a group of fuel injection equipment with parallel electrical connection has been carried out.

Analysis of the research results showed the possibility of selecting the optimum supply voltage for the group of fuel injection equipment with parallel electric connection in the relationship of energy, mass-dimensional and dynamic characteristics, taking into account the reliability indicators of the complex as a whole.

It should be noted that as the supply voltage U decreases, the power, mass-dimensional and dynamic characteristics of a group of TEC with parallel electrical connection improve, and the reliability of a complex with mixed electrical connection in an uneven temperature field increases.

REFERENCES

1. Gordon, N. E. “Thermal computations for electronics, conductive, radiative and convective air cooling”. *CRC Press. Boca Raton.* 2020. 404 p. ISBN 9781003029328. DOI: <https://doi.org/10.1201/9781003029328>.
2. Sulaiman, A. C., Amin, N. A. M., Basha, M. H., Majid, M. S. A., Nasir, N. F. b. M. & Zaman, I. “Cooling performance of thermoelectric cooling (TEC) and applications: A Review. *MATEC” Web Conf.* 2018; Vol. 225: 03021. DOI: <https://doi.org/10.1051/mateconf/201822503021>.
3. Venkatesan, K. & Venkataramanan, M. “Experimental and simulation studies on thermoelectric cooler: A performance study approach”. *International Journal of Thermophysics*; 2020; 41. DOI: <https://doi.org/10.1007/s10765-020-2613-2>.
4. Wang, L. Q., Zhou, L. & Fan, H. T. “Design of cooling system for infrared CCD camera used to monitor burden surface of blast furnace based on thermoelectric coolers”. *Applied Mechanics and Materials.* 2013; 419: 778–783. DOI: <https://doi.org/10.4028/www.scientific.net/AMM.419.778>.
5. Yu, J., Zhu, Q., Kong, L., Wang, H. & Zhu, H. “Modeling of an integrated thermoelectric generation–cooling system for thermoelectric cooler waste heat recovery”. *College of Aerospace and Civil Engineering, Harbin Engineering University, Harbin 150001, China. Energies.* 2020; 13 (18): 4691. DOI: <https://doi.org/10.3390/en13184691>.
6. Manikandan, S., Kaushik, S.C. & Yang, R. “Modified pulse operation of thermoelectric coolers for building cooling applications”. *Energy Conversion and Management.* 2017; 140: 145–156. DOI: <https://doi.org/10.1016/j.enconman.2017.03.003>.
7. Dong, X. & Liu, X. “Multi-objective optimal design of microchannel cooling heat sink using topology optimization method”. *Numerical Heat Transfer, Part A: Applications.* 2020; 77 (1): 90–104. DOI: <https://doi.org/10.1080/10407782.2019.1682872>.
8. Ebale, L. O., Pierre Gomat, L. J., Nzonzolo, L., Mavoungou, M. R. & Kibongani, F. “Optimization of a thermoelectric cooling system with peltier effect”. *Am. J. Energ. Eng.* 2019; 7 (3): 55–63. DOI: <https://doi.org/10.11648/j.sjee.20190703.12>.
9. Erturun, U., Mossi, K. & “A Feasibility investigation on improving structural integrity of thermoelectric modules with varying geometry”. 2012. p. 939-945 DOI: <https://doi.org/10.1115/SMASIS2012-8247>.
10. Cai, Y., Wang, Y., Liu, D. & Zhao, F.-Y. “Thermoelectric cooling technology applied in the field of electronic devices: updated review on the parametric investigations and model developments”. *Appl. Therm. Eng.* 2019; 148: 238–255. DOI: <https://doi.org/10.1016/j.applthermaleng.2018.11.014>.
11. Irshad, K., Almalawi, A., Khan, A. I., Alam, M. M., Zahir, M. H. & Ali, A. “An IoT-Based thermoelectric air management framework for smart building applications: a case study for tropical climate”. *Sustainability.* 2020; 12(4): 1–18. DOI: <https://doi.org/10.3390/su12041564>.
12. Ngo, T.-T., Wang, C.-C., Chen, Y.-T. & Than, V.-T. “Developing a thermoelectric cooling module for control temperature and thermal displacement of small built-in spindle”. *Therm. Sci. Eng. Prog.* 2021; 25: 100958. DOI: <https://doi.org/10.1016/j.tsep.2021.100958>.
13. Choi, H. S., Seo, W. S. & Choi, D. K. “Prediction of reliability on thermoelectric module through accelerated life test and physics-of-failure”. *Electron. Mater. Lett.* 2011; 7. DOI: <https://doi.org/10.1007/s13391-011-0917-x>.
14. Song, H., Song, K. & Gao, C. “Temperature and thermal stress around an elliptic functional defect in a thermoelectric material”. *Mechanics of Materials.* 2019; 130: 58–64. DOI: <https://doi.org/10.1016/j.mechmat.2019.01.008>.
15. Karri, N.K. & Mo, C. “Structural reliability evaluation of thermoelectric generator modules: influence of end conditions, leg geometry, metallization, and processing temperatures”. *Journal of Electronic Materials.* 2018; 47 (10): 6101–6120. DOI: <https://doi.org/10.1007/s11664-018-6505-1>.
16. Kim, H. S., Wang, T., Liu, W., & Ren, Z. “Engineering thermal conductivity for balancing between reliability and performance of bulk thermoelectric generators”. *Advanced Functional Materials.* 2016; 26: 3678–3686. DOI: <https://doi.org/10.1002/adfm.201600128>.

17. Zaykov, V., Mescheryakov, V. & Zhuravlov, Yu. “Studying the influence of the thermoelectric materials parameters on the dynamics of singlecascade cooling devices”. *Eastern-European Journal of Enterprise Technology*. <https://www.scopus.com/authid/detail.uri?authorId=57192640885>. 2020; 8 (103): 6–18. DOI: <https://doi.org/10.15587/1729-4061.2020.195730>.

18. Zaykov, V., Mescheryakov, V. & Zhuravlov, Yu. “Designing a singlecascade thermoelectric cooler with the predefined time to enter a stationary mode of operation”. *Eastern-European Journal of Enterprise Technologies*. <https://www.scopus.com/authid/detail.uri?authorId=57192640885>. 2019; 102: 38–46. DOI: <https://doi.org/10.15587/1729-4061.2019.184400>.

19. Zaykov, V.P., Kinshova, L. A. & Moiseev, V. F. “Prediction of reliability indicators, thermoelectric cooling devices. Book 1. One-stage devices”. *Publ. Polytehpriodika*, Odessa: Ukraine. 2009. 120 p.

20. Zaykov, V., Mescheryakov, V. & Zhuravlov, Y. “Analysis of relationship between the dynamics of a thermoelectric cooler and its design and modes of operation”. *Eastern-European Journal of Enterprise Technologies*. <https://www.scopus.com/authid/detail.uri?authorId=57192640885>. 2018; 8 (91): 12–24. DOI: <https://doi.org/10.15587/1729-4061.2018.123891>.

Conflicts of Interest: the authors declare no conflict of interest

Received 10.10.2022

Received after revision 12.11.2022

Accepted 22.11.2022

DOI: <https://doi.org/10.15276/hait.05.2022.23>

УДК 004.662.99·519.6

Управління комплексом термоелектричних охолоджуючих пристроїв зі змішаним електричним з'єднанням у нерівномірному температурному полі

Зайков Володимир Петрович¹⁾

ORCID: <http://orcid.org/0000-0002-4078-3519>; gradan@i.ua. Scopus Author ID: 57192640250

Мещеряков Володимир Іванович²⁾

ORCID: <http://orcid.org/0000-0003-0499-827X>; gradan@ua.fm. Scopus Author ID: 57192640885

Журавльов Юрій Іванович³⁾

ORCID: <http://orcid.org/0000-0001-7342-1031>; ivanovich1zh@gmail.com. Scopus Author ID: 57190425471

¹⁾ Науково-дослідницький інститут ШТОПМ, вул. Терешкової 27. Одеса, 65076, Україна

²⁾ Одеський державний екологічний університет, вул. Львівська, 15. Одеса, 65026, Україна

³⁾ Національний університет «Одеська морська академія», вул. Дідріхсона, 8. Одеса, 65029, Україна

АНОТАЦІЯ

Розглянуто можливість оптимального управління тепловим режимом ряду термозалежних і теплонавантажених елементів радіоелектронної апаратури з різною потужністю розсіяння у нерівномірному температурному полі з використанням комплексу термоелектричних охолоджуючих пристроїв зі змішаним електричним з'єднанням і фіксованою геометрією гілок термоелементів. Одержані співвідношення для визначення відносного робочого струму, який відповідає мінімальному значенню напруги живлення при заданому тепловому навантаженні для різних перепадів температур і геометрії гілок термоелементів. Показано можливість вибору напруги живлення для групи термоелектричних охолоджувачів з паралельним електричним з'єднанням з використанням як аналітичного так і графічного методу вирішення системи алгебраїчних рівнянь першого і другого порядку. Приведена оцінка основних параметрів, показників надійності і динамічних характеристик комплексу термоелектричних охолоджувачів з послідовним електричним з'єднанням в режимі максимальної холодопродуктивності і варіацією напруги живлення групи охолоджувачів з паралельним електричним з'єднанням. Аналіз результатів дослідження показав можливість вибору оптимальної напруги живлення групи термоелектричних охолоджувачів з паралельним електричним з'єднанням у взаємозв'язку енергетичних, масогабаритних в динамічних характеристик з врахуванням показників надійності комплексу в цілому. Показано, що зі зменшенням напруги живлення групи з паралельним електричним з'єднанням, які входять в комплекс, покращуються енергетичні, масогабаритні і динамічні характеристики, підвищуються показники надійності комплексу зі змішаним електричним з'єднанням у нерівномірному температурному полі.

Ключові слова: термоелектричний охолоджувач; тепловий режим; моделі з'єднання; напруга живлення; показники надійності; динамічні характеристики
Copyright © Національний університет «Одеська політехніка», 2022. Всі права захищені

ABOUT THE AUTHORS



Vladimir P. Zaykov - PhD in Engineering Sciences, Head of Sector. Research Institute “STORM”. 27, Tereshkova Str. Odessa, 65076, Ukraine
ORCID: <http://orcid.org/0000-0002-4078-3519>; gradan@i.ua. Scopus Author ID: 57192640250.
Research field: Reliability and dynamic descriptions of thermo-electric cooling devices; design, planning of the systems of providing of the thermal modes of electronic apparatus

Зайков Володимир Петрович - кандидат технічних наук, начальник сектору науково-дослідного інституту «ШТОРМ», вул. Терешкової 27. Одеса, 65076, Україна



Vladimir I. Mescheryakov - Doctor of Engineering Sciences, Professor, Head of Department of Informatics. State Environmental University, 15, Lvivska Str. Odessa, 65026, Ukraine.
ORCID: <http://orcid.org/0000-0003-0499-827X>; gradan@ua.fm. Scopus Author ID: 57192640885
Research field: Reliability and dynamic descriptions of thermo-electric cooling devices; design of power processes; biotechnical informative systems

Мещеряков Володимир Іванович - доктор технічних наук, зав. кафедри Інформатики. Одеський державний екологічний університет, вул. Львівська, 15. Одеса, 65026, Україна



Yurii I. Zhuravlov - PhD in Engineering Sciences, Associate Professor of Department of Technology of Materials and Ship Repair. National University “Odessa Maritime Academy”, 8, Didrikhson Str. Odessa, 65029, Ukraine
ORCID: <http://orcid.org/0000-0001-7342-1031>; jvanovich1zh@gmail.com. Scopus Author ID: 57190425471
Research field: Reliability and dynamic descriptions of thermo-electric cooling devices; reliability and reparability of ship equipment

Журавльов Юрій Іванович - кандидат технічних наук, доцент кафедри Технології матеріалів і судноремонту. Національний університет “Одеська морська академія”, вул. Дідріхсона, 8. Одеса, 65029, Україна